

# Application Note

By **JEL SYSTEM Co., LTD**

Official Web Site

<https://www.jelsystem.co.jp/en/>



株式会社 シェルシステム  
JEL SYSTEM CO., LTD.

# Contents

<input type="checkbox"/> Outline of SSR.....	3
<input type="checkbox"/> Heater Load.....	4
<input type="checkbox"/> Injection Molding Machine.....	6
<input type="checkbox"/> Mold Temperature Control.....	7
<input type="checkbox"/> Chiller.....	8
<input type="checkbox"/> Reflow Oven.....	9
<input type="checkbox"/> Packing Machine.....	10
<input type="checkbox"/> Elevator.....	11
<input type="checkbox"/> Printing Machine.....	12



# Outline of SSR

**A** **solid state relay (SSR)** is a non-contact semiconductor control component where the input side and output side are isolated like an electromagnetic relay (EMR), and the semiconductor device that uses a semiconductor element for the electrical circuit switch to make it non-contact.

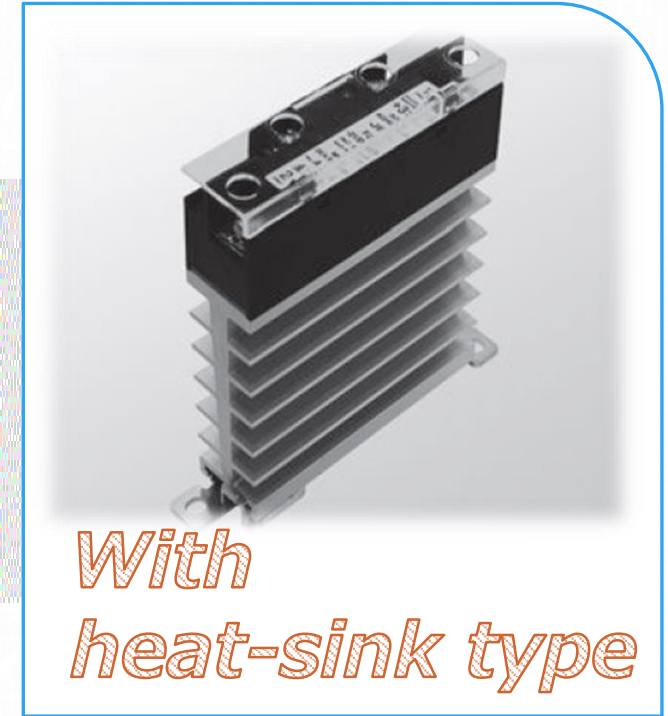
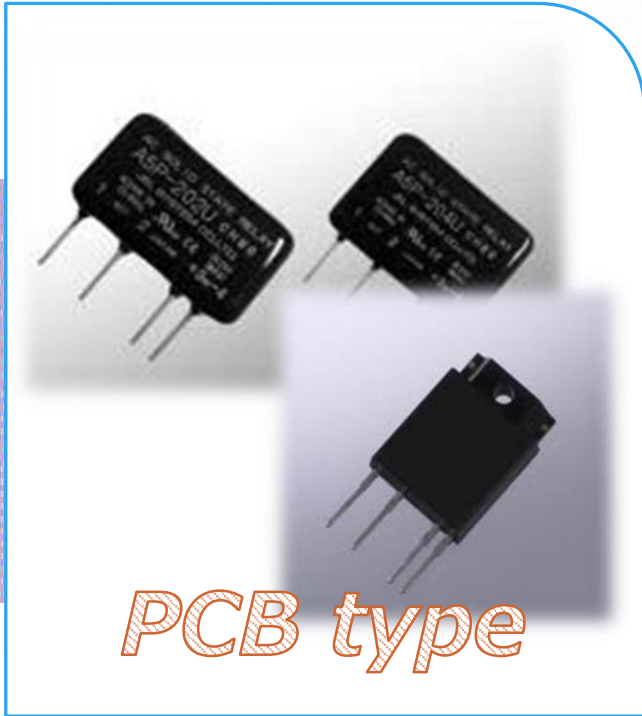

## THE SOLID STATE RELAY TECHNOLOGY

made in JAPAN for more than 50 years !



株式会社 ジェルシステム  
JEL SYSTEM CO., LTD.



# Heater Load 1 (Example : Cooker)

Temperature Controller



Input temperature

Temperature Sensor

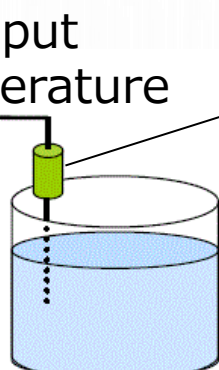

Heater Power



Heater

Control Output

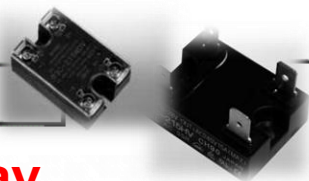

**Solid State Relay**

°C : Degree

**PID Control**

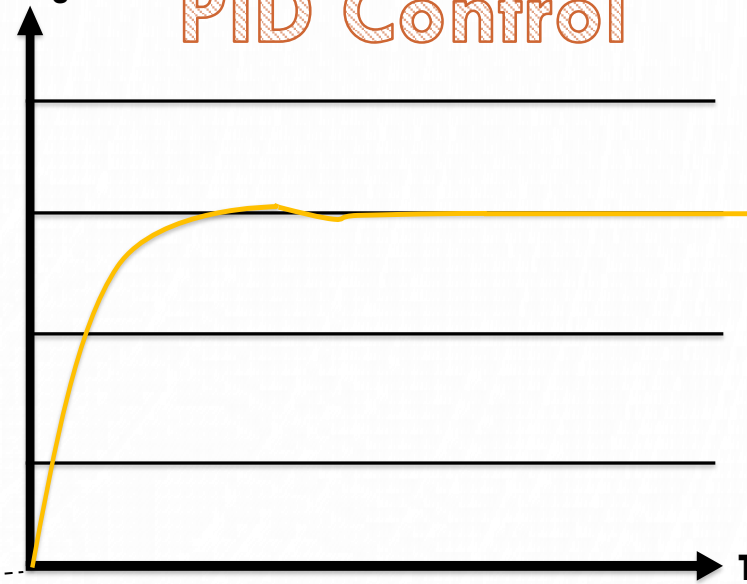

## How to control “temperature” by Solid State Relay ?

1. Attach a temperature sensor to the target cooker and measure the temperature.
2. If the measured temperature is low, SSR turn on and the heater will heat up.
3. If the measured temperature rises, SSR turn off and the heater will stop heating.

Maintain the set temperature of the cooker by repeating step 2 to step 3.

# Heater Load 2 (Example : Cooker)

## KEY POINT of "heater control"

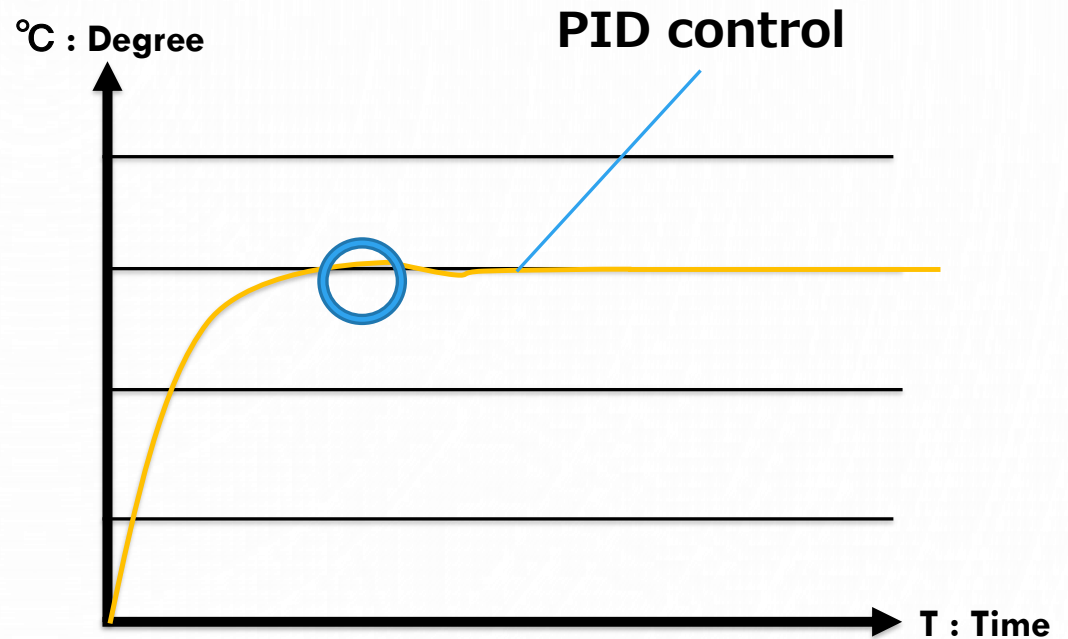
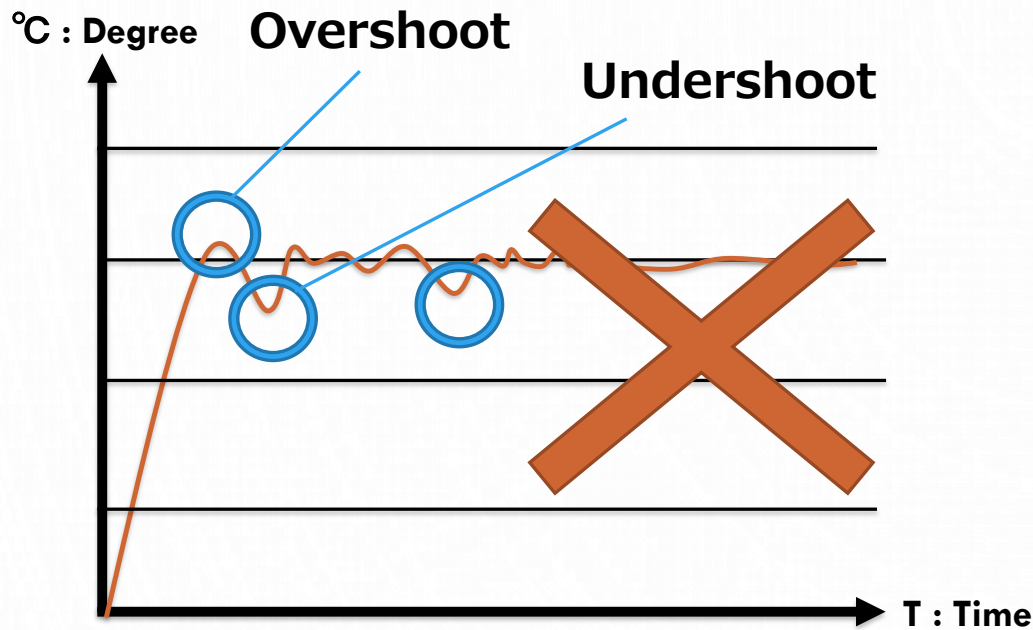

The temperature controller controls the current temperature and the target temperature so that they match, however the temperature of the "cooker" changes constantly depending on the ambient temperature and the input of ingredients etc.

As the right figure, in order to reach the target temperature under various conditions without overshooting, it is necessary SSR control.

(※ The figure is just an example)

# Injection Molding Machine

“Injection Molding Machine” is able to create some products by synthetic resin. For example, plastic bottle is made by this machine. As below figure, Plastic Pellets is thrown from Hopper and it will melt by heater. After that, melted plastic pellets will be injected to the mold by screw and generated by here.

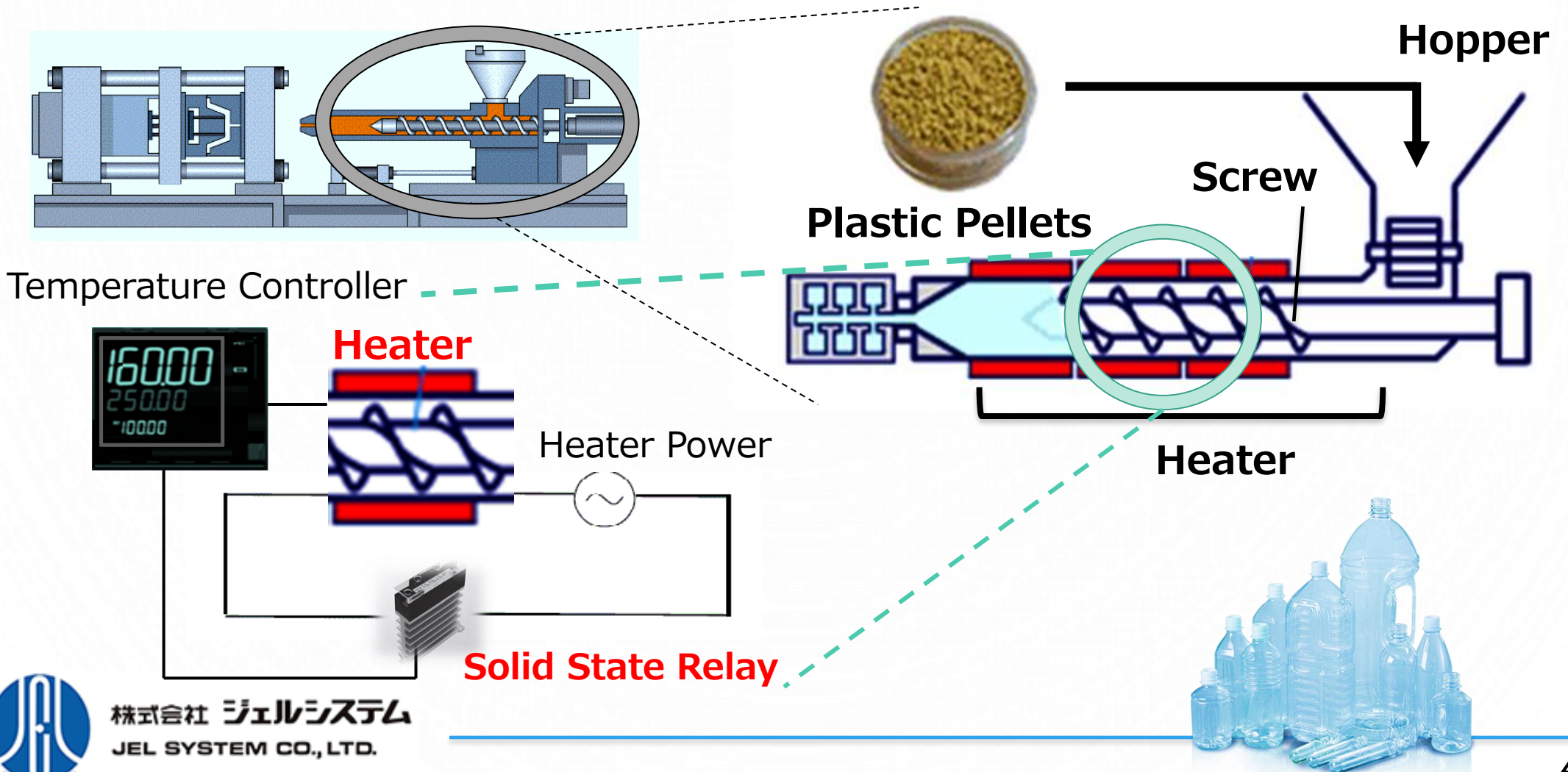

株式会社 ジェルシステム  
JEL SYSTEM CO., LTD.



# Mold Temperature Controller

## Mold Temperature Controller

## Injection Molding Machine

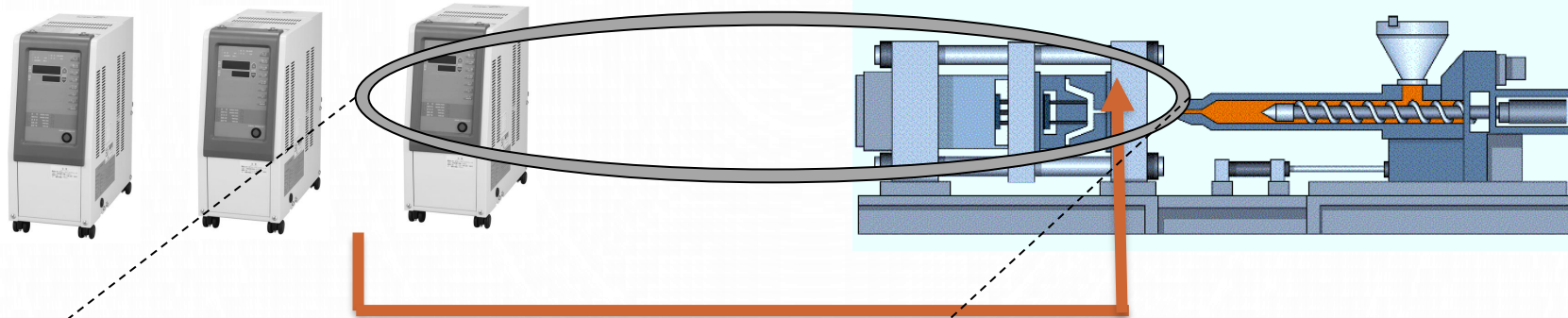

Controlling temperature

[ Mold Temperature Controller ]

Heater

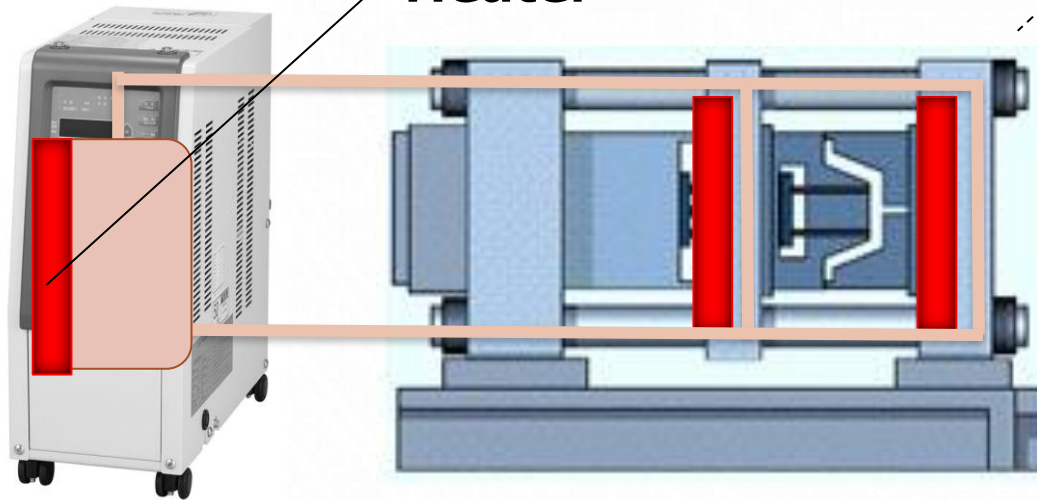

Water or oil is heated by a heater and forcibly pressed into the mold with a pump while maintaining an appropriate temperature.

And heat is exchanged between the heat medium (water or oil) and the mold.

It will eliminate manufacture irregularity products by keeping the temperature of the mold.

# Chiller

A chiller is a machine that circulates water to control the temperature of a machine (part of the machine) such as chilling or heating. Water circulate by adjusting the temperature of the water using a refrigerator or heater. It is aimed primarily at chilling but also, tap water may chill the machine. As this figure, the hopper of injection machine is been chilling by running water.

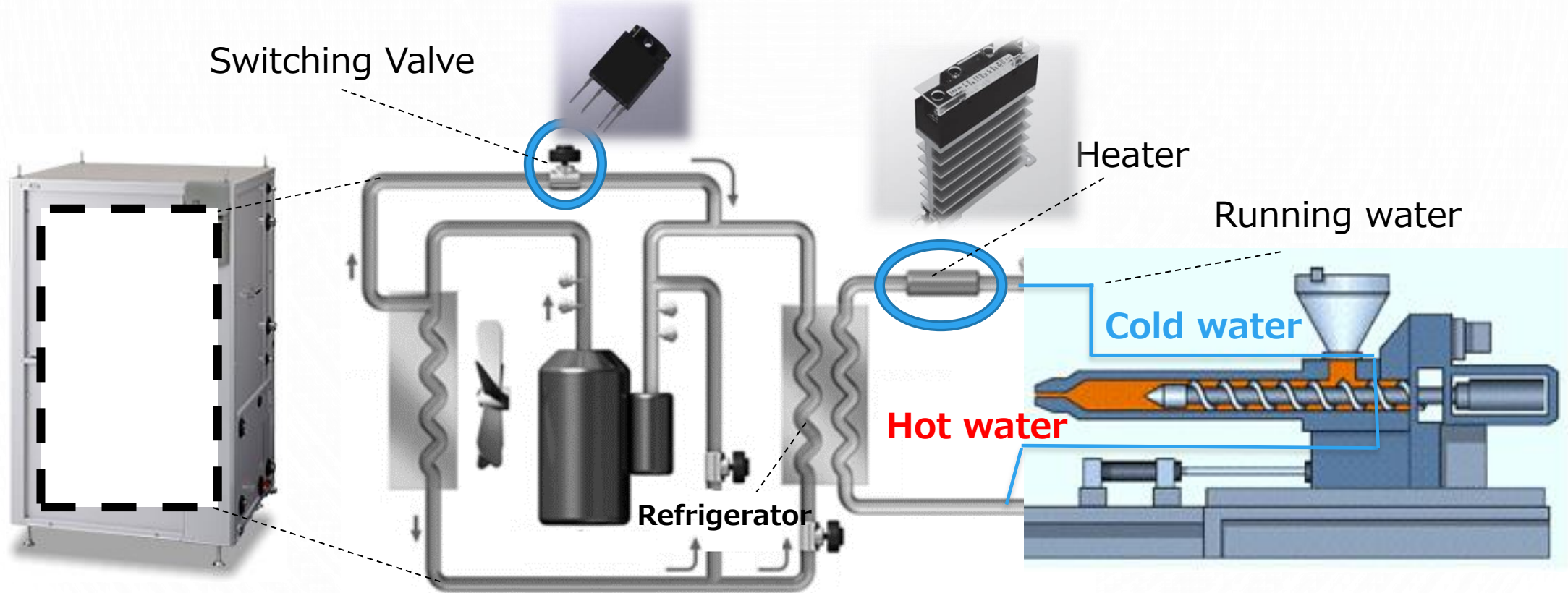



# Reflow Oven

The reflow oven is soldering machine that has been soldered “cream solder” at normal temperature in advance must be heated and melted later for soldering.

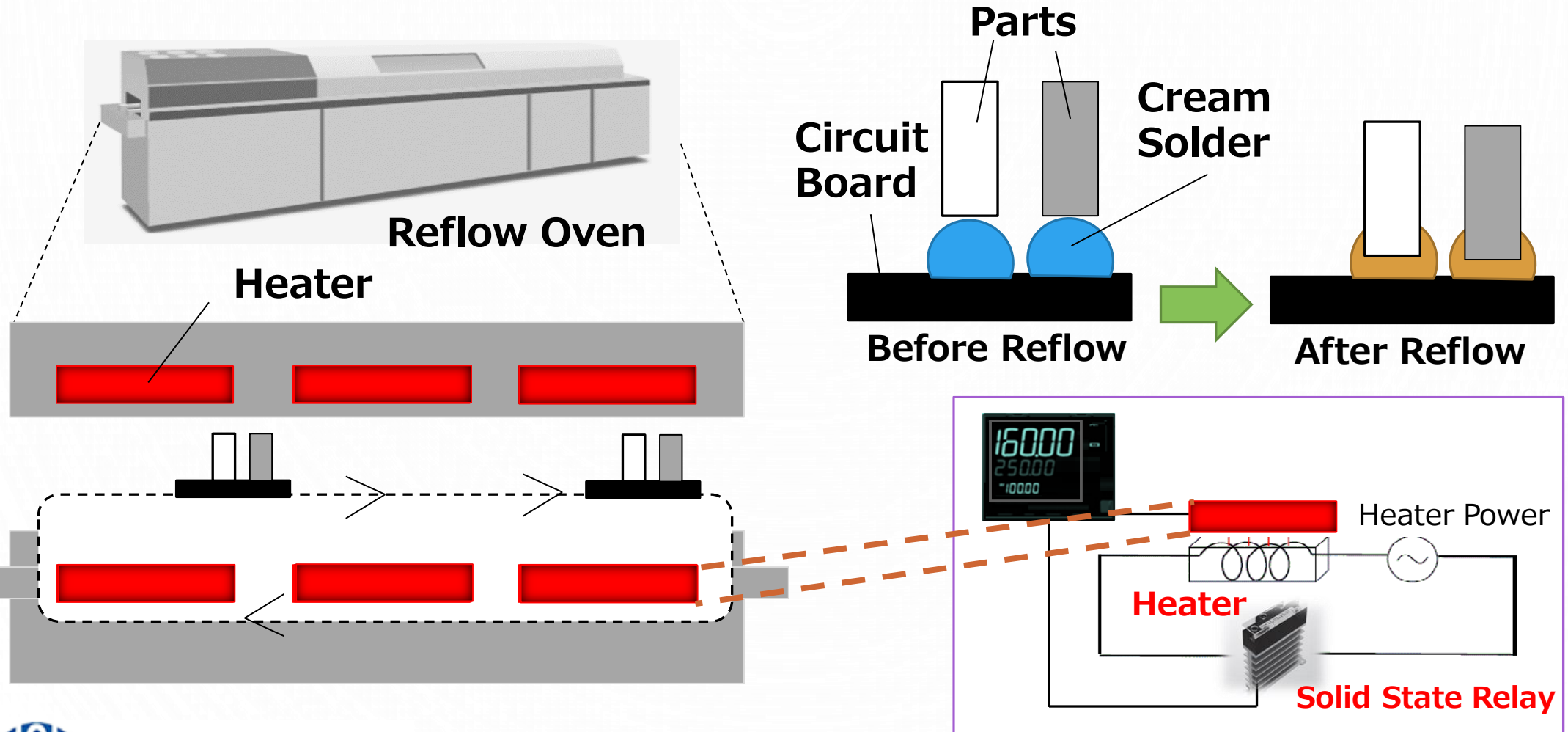

# Packing Machine

Packing machine is that automatically packs some products, especially it is used when wrapping food. As picture below, it is wrapping by sealing at heater. So it is most important things is strict temperature control.

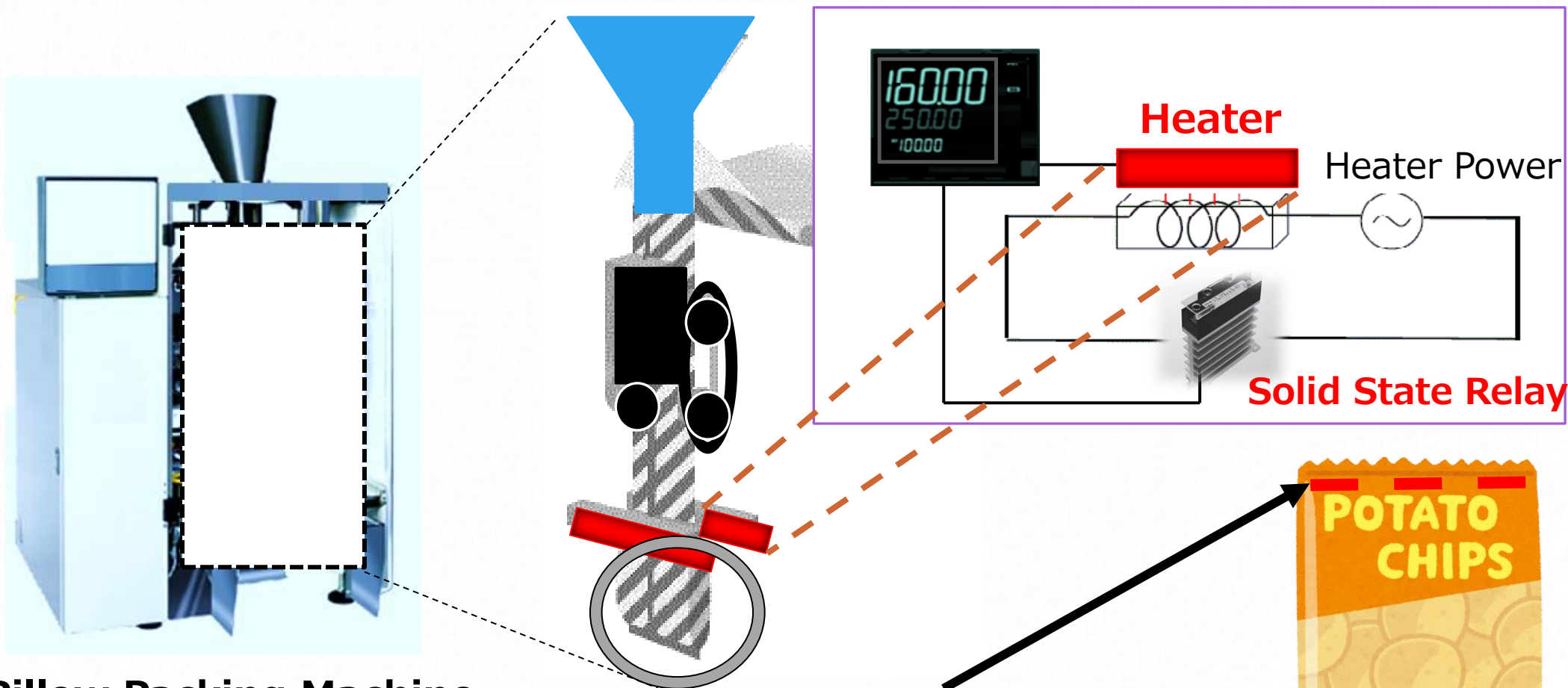

Pillow Packing Machine

It is sealed by heater



株式会社 ジェルシステム  
JEL SYSTEM CO., LTD.

# Elevator

SSR are used to control "Push Buttons" and "Lighting of floor display" in the elevator.

Lighting of floor display

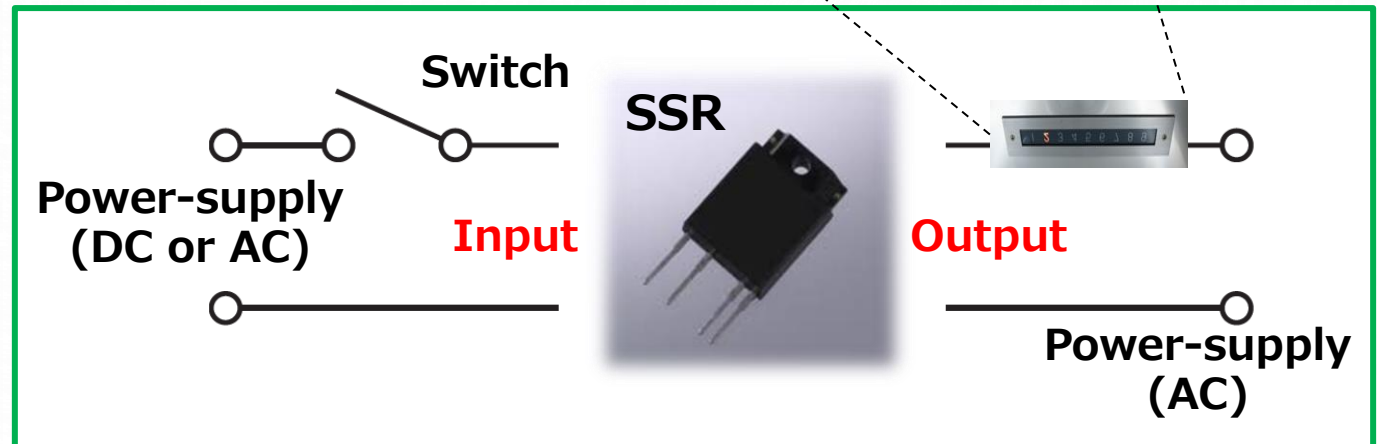
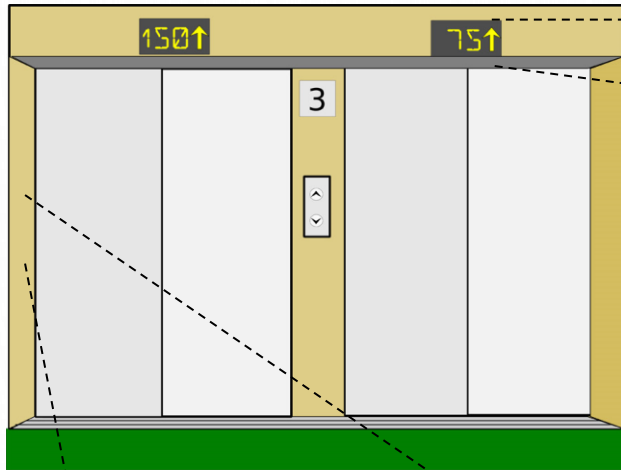

Push Buttons





# Printing Machine

SSR is used to switch "induction motors" in commercial printing machine.

## Printing Machine

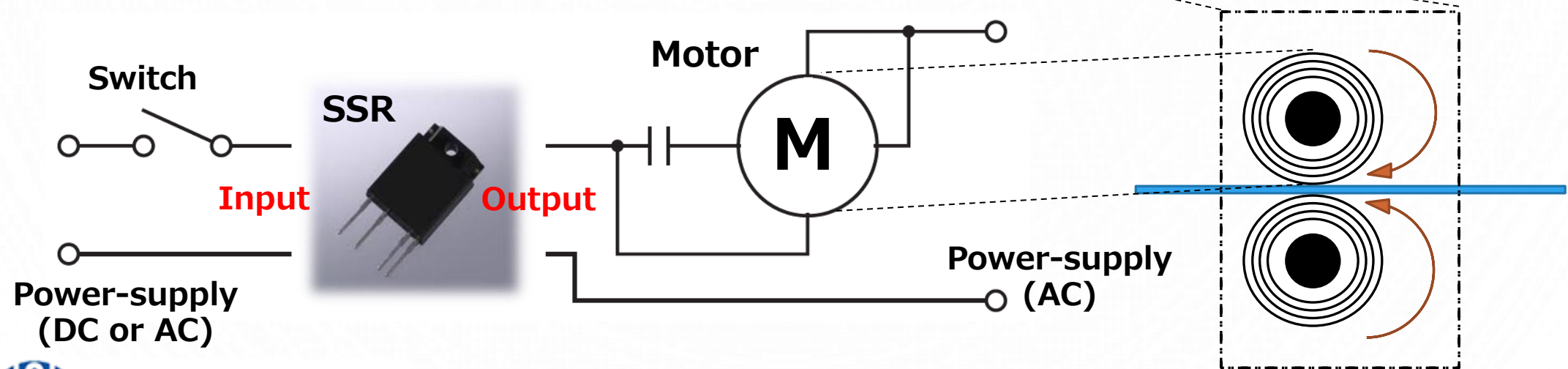
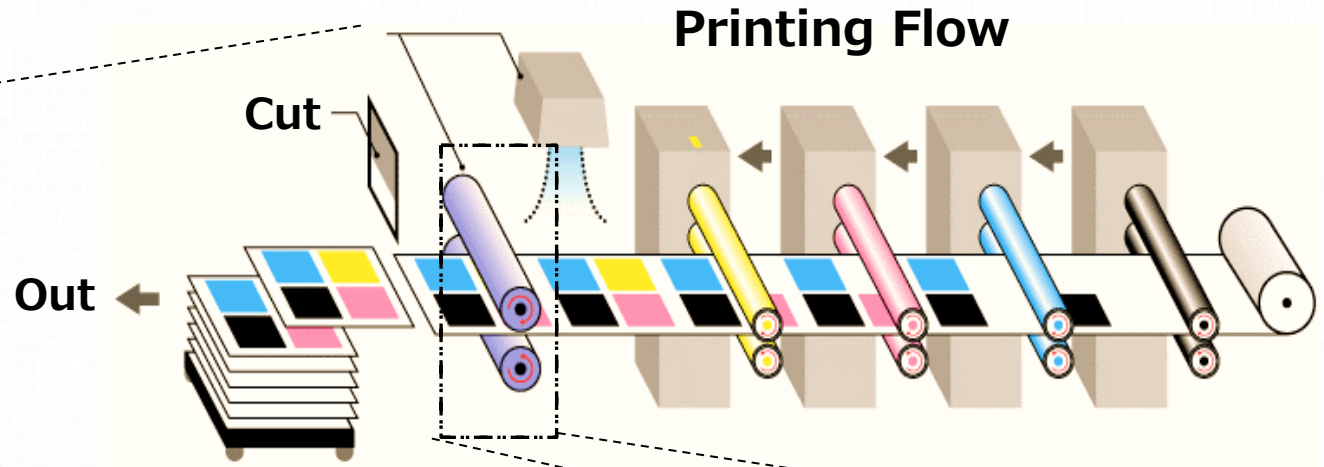
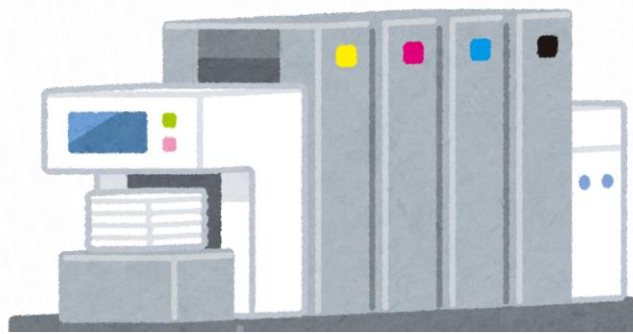

株式会社 ジェルシステム  
JEL SYSTEM CO., LTD.